

# Recognise and describe 3D shapes

- 1 Kim paints the faces of some 3D shapes.  
She stamps the faces on to a sheet of paper.  
Match the stamp to the 3D shape.

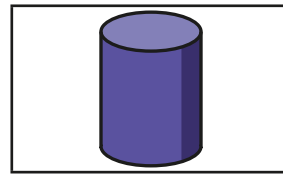

- 2 A cube is a special type of cuboid.

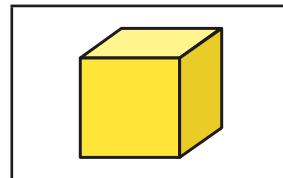
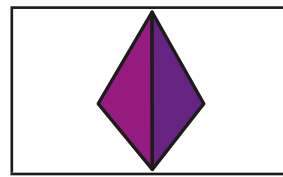
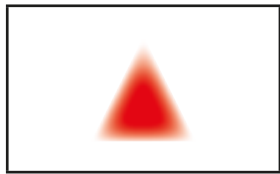
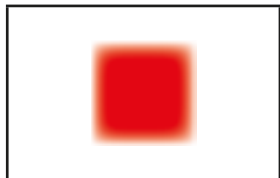
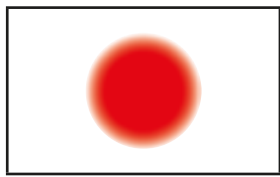
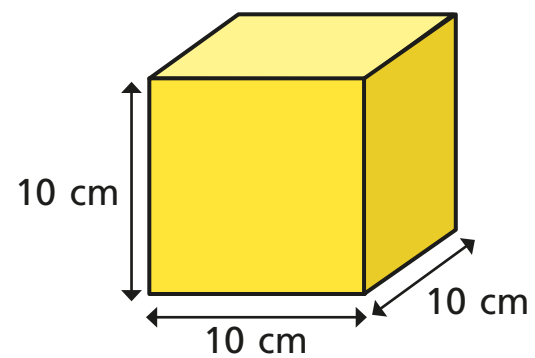

What is special about each face of a cube?  
Talk about it with a partner.

- 3 Which of the shapes is a cube? Tick your answer.

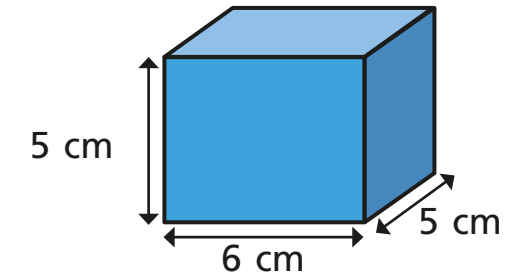
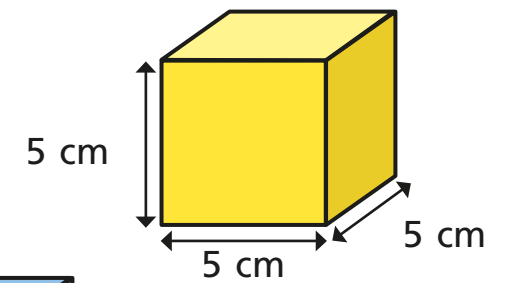

- 4 Here is a cuboid.

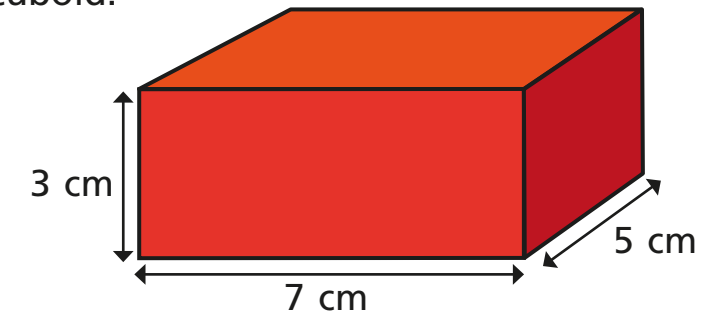

What do you notice about the opposite faces of a cuboid?

---



---

- 5 Match the 3D shapes to the labels.

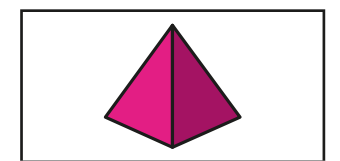
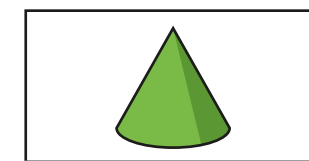
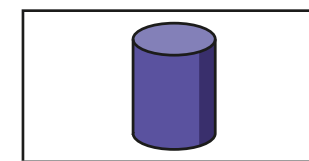

square-based  
pyramid

cylinder

cone





6 Here are some shapes.

a) Circle all the triangular prisms.

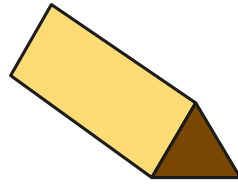
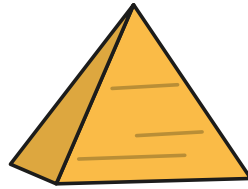

b) Circle all the spheres.

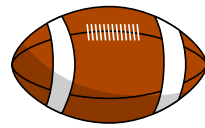

7 Complete the table.

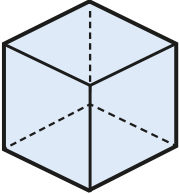
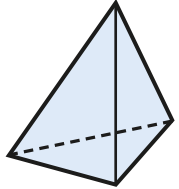
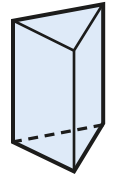
Shape	Number of edges	Number of faces	Number of vertices
			
			
			

8 Here is a cuboid.

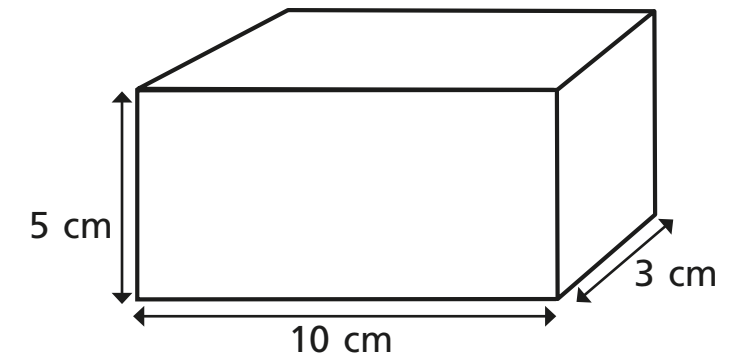

a) Shade a face that is a 5 cm by 3 cm rectangle.

b) What are the measurements of one of the other faces?

cm by  cm

9 Huan sorts some shapes into prisms and non-prisms.

Prisms

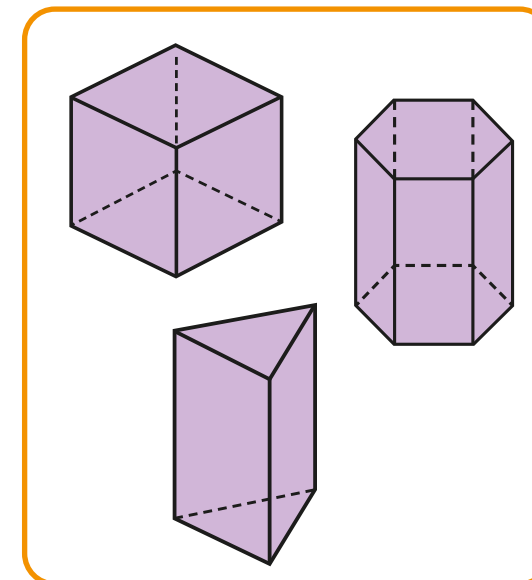

Non-prisms

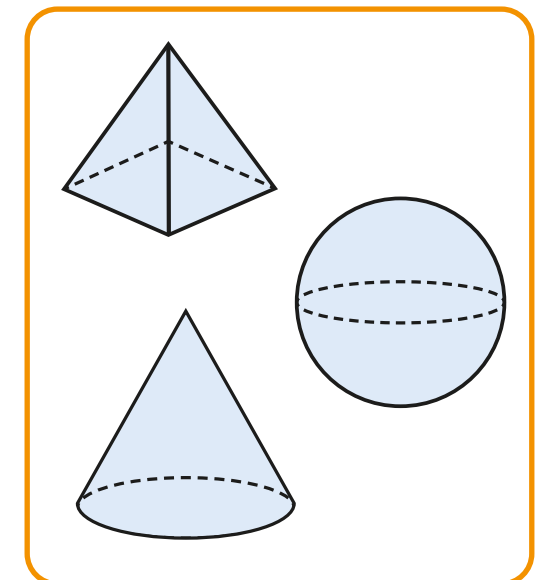

Talk to a partner about what a prism is like.

Can you find any prisms and non-prisms in your classroom?

